



DuraLabel **BRONCO**

USER GUIDE



800.788.5572

GraphicProducts.com

Minimum System Requirements

- Operating System: Windows XP Service Pack 2 (or later), Windows Vista, Windows 7, or Windows 8 or 8.1. Both 32-bit (x86) and 64-bit (x64) systems are supported.
- Memory: 128MB RAM
- Hard Drive Space: 100MB
- IT / Administrator Privileges for installation

Your label design software may have other requirements.

Supplies

DuraLabel supplies and DuraLabel® Bronco printers have been optimized for compatibility and print quality. Use only DuraLabel supplies from Graphic Products with your DuraLabel Bronco printer.

Copyright Information

This manual is copyrighted with all rights reserved. No portion of this manual may be copied or reproduced by any means without the prior consent of Graphic Products, Inc.

While every precaution has been taken in preparation of this document, Graphic Products, Inc. assumes no liability to any party for any loss or damage caused by errors or omissions or by statements resulting from negligence, accident or any other cause. Graphic Products, Inc. further assumes no liability for incidental or consequential damages arising from the use of this document. Graphic Products, Inc. disclaims all warranties of merchantability or fitness for a particular purpose.

Graphic Products, Inc. reserves the right to make changes without further notice to any product or system herein to improve reliability, function or design.

Reproduction of this material, in part or whole, is strictly prohibited without the written permission of Graphic Products, Inc.



Home of DuraLabel®

Safety Warnings

Before connecting Bronco to a power outlet, check the voltage of the power source. Bronco needs a power supply between 100 and 240 volts. Ensure that the power switch on the printer is in the OFF position.

Only use the included power supply with the Bronco (rated for 24V/2.5A output, model WDS060240). If a replacement is needed, please contact your DuraLabel representative.

To avoid electrical shock, DO NOT pour any liquid onto the printer or printer parts.

Only qualified service personnel should attempt to repair the printer.

Changes or modifications not expressly approved by the party responsible for compliance could void the user's authority to operate the equipment.

Avant de brancher Bronco à une prise de courant, vérifier la tension de la source d'alimentation, et faire en sorte que le commutateur d'alimentation de l'imprimante est en position OFF.

Utilisez uniquement le bloc d'alimentation fourni avec le Bronco (classé pour la sortie 24V / 2.5A, modèle WDS060240). Si un remplacement est nécessaire, s'il vous plaît contactez votre Duralabel représentant.

Pour éviter un choc électrique, NE PAS verser de liquide sur les parties de l'imprimante ou l'imprimante.

Seul le personnel d'entretien qualifié doit tenter de réparer l'imprimante.

Contents

- 1. Introduction 5**
- 2. Getting Started 6**
 - 2.1 What's in the Box 6
 - 2.2 Know Your Bronco 7
 - 2.2.1 Exterior 7
 - 2.2.2 Connection Panel 7
 - 2.2.3 Interior - Print Head Carriage Locked 8
 - 2.2.4 Interior - Print Head Carriage Released 8
- 3. Loading Supplies 9**
 - 3.1 Loading Ribbon 9
 - 3.2 Loading Label Stock 10
- 4. Connecting the Printer 11**
- 5. Choosing Driver Settings 13**
 - 5.1 Page Setup 13
 - 5.2 Graphics 13
 - 5.3 Stock 14
 - 5.3.1 Print Method 14
 - 5.3.2 Media Type 14
 - 5.3.3 Post-Print Action 14
 - 5.3.4 Occurrence 14
 - 5.4 Options 15
- 6. Installing Labeling Software 16**
 - 6.1 Installing DuraSuite Labeling Software 16
 - 6.2 Installing LabelForge Labeling Software 16
- 7. Maintenance and Troubleshooting 17**
 - 7.1 Cleaning Your Bronco 17
 - 7.2 Troubleshooting 17
 - 7.2.1 Recalibrating Bronco's Sensors 17
 - 7.2.2 Checking Supply Loading 18
- 8. Warranty and Certifications 20**
 - 8.1 5-Year DuraLabel Printer Warranty 20
 - 8.1.1 Repairs 20
 - 8.1.2 Warranty Details 20
 - 8.2 5-Year DuraLabel Premium Vinyl Warranty 21
 - 8.3 FCC Compliance 21
 - 8.4 US, Canadian and European EMC and EMI standards 21
- 9. Contact Us 22**

1. Introduction

Congratulations! Now that you have your DuraLabel Bronco sign and label printer, you'll be creating custom labels in no time.

In addition to helping you set up and use Bronco, this User Guide will serve as a reference document for maintaining the system, and for using its more advanced features.

The included DuraSuite software helps you create labels in a variety of standardized formats, such as GHS and HazCom 2012 labels, NFPA 704 (NFPA Diamond) chemical labels, NFPA 70E arc flash labels, and ANSI/ASME A13.1 pipe markers and IIAR ammonia pipe markers. For information on that software, see the DuraSuite User Guide.

Bronco also comes with LabelForge for creating completely customized label designs from scratch, using a simple interface. LabelForge gives you the power to instantly create linear and 2D barcodes, add standardized symbols or custom images, and even import data from a spreadsheet. For information on that software, see the LabelForge User Guide.

If you need supplies, or have questions about Bronco or the DuraSuite or LabelForge software, give us a call at 800.788.5572 (or, internationally, at 1.503.644.5572) and we'll be happy to help.



REMINDER: Periodic cleaning is required for your printer's operation, as adhesive and dust will build up during use. Clean the print head, platen roller, and cutter blades with a provided cleaning swab, or with isopropyl alcohol and a soft cloth, after every 2-3 rolls of supply. See section **7.1, *Cleaning your Bronco***, for details, or watch instructional videos at GraphicProducts.com/support.



2. Getting Started

2.1 What's in the Box

- Bronco Printer
- User Documentation
- Bronco Software CD
- AC Power Adapter
- USB Cord
- Supply Spindle and Fixing Tabs
- Ribbon Take-Up Core



If any of these items are missing, please contact your DuraLabel representative.

2.2 Know Your Bronco

2.2.1 EXTERIOR

Feed/Cancel Button
and Indicator Light

Cutter Slot



2.2.2 CONNECTION PANEL

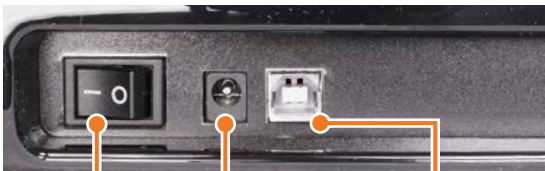

Power Switch

Power Supply Connection

USB Connection

2.2.3 INTERIOR – PRINT HEAD CARRIAGE LOCKED

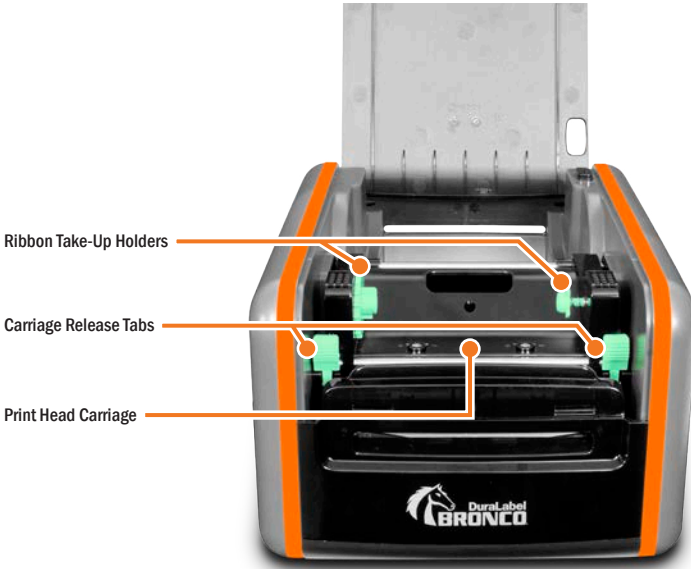

2.2.4 INTERIOR – PRINT HEAD CARRIAGE RELEASED

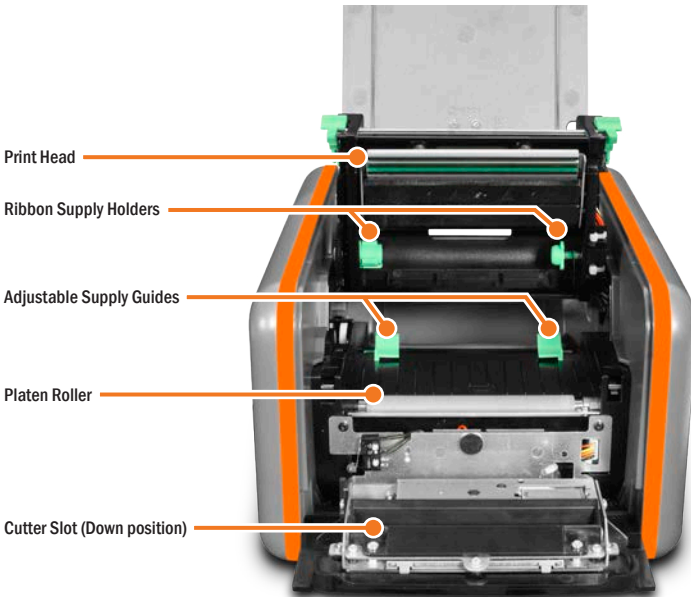

3. Loading Supplies

To open your Bronco and load supplies, start by raising Bronco's lid, lifting at the front edge, above the cutter opening. You can also gently pull the cutter mechanism forward to lower it out of the way.

You need two supplies to print: the printing ribbon, or "ink," and the label stock, or "vinyl."

3.1 Loading Ribbon

Ribbon comes in a roll, which fits underneath the print carriage. When printing, Bronco will transfer colored resin from the ribbon onto your label stock, with the used ribbon collecting on a take-up core above the print carriage for later disposal.

1. Start with an empty rewind core. Fit one end of the core onto the green spring-loaded holder on the top of the print head carriage. Then, fit the other end of the ribbon core onto the wheeled holder. Turn the take-up core or holder by hand, until the tab on the holder locks into the notch in the core.
2. Then, press the two green carriage release tabs. The print head carriage will spring upward.
3. Hold the new roll of ribbon so the loose end falls to the rear of the printer. Fit one end of the ribbon core onto the green spring-loaded holder on the underside of the print head carriage. Then, fit the other end of the ribbon core onto the geared holder. Turn the ribbon core by hand until the tab on the holder locks into the notch in the core.
4. Pull the loose end of the ribbon up and around the print head carriage and use a small piece of label stock or tape to secure the end of the ribbon to the top of the empty rewind core.
5. Pull the ribbon snug by turning the green take-up wheel.

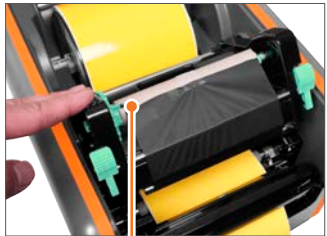
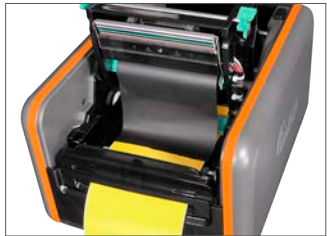

3.2 Loading Label Stock

Fresh label stock comes in a roll with plastic end caps on each side. The material typically has a glossy print surface on one side, and a disposable paper backing on the other side. When printing, Bronco will feed some of the label stock from its roll and cut off the printed label.

1. If you haven't already done so, raise the print head carriage by pressing the two green carriage release tabs.
2. Place the roll of label stock onto the supply spindle. For narrow rolls of label stock, use the two fixing tabs to keep the supply roughly centered.
3. With the label stock unrolling from the top of the roll and feeding toward the print head carriage, rest the supply spindle into its slots in your Bronco.
4. Feed the end of the label supply under the print carriage, threading it between and beneath the green adjustable label guides, and over the top of the rubber roller near the cutter module.
5. Slide the green adjustable label guides together to keep the label stock centered, but not so tight as to bend or wrinkle the label stock.
6. Close the print head carriage by pressing it down into place, and then close Bronco's lid.

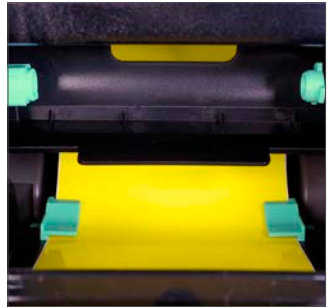
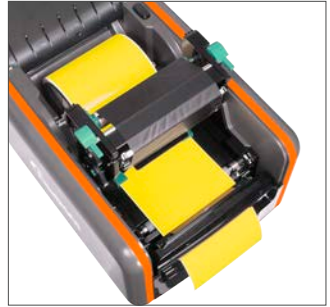

4. Connecting the Printer

When connecting your Bronco to a computer for the first time, follow these steps.

NOTE: You may need IT administrator privileges to install a driver.

1. Connect the power supply from the DuraLabel Bronco printer to an electrical outlet. Next, connect the USB cable from the DuraLabel Bronco to your PC. Turn on your Bronco using the power switch on the back of the printer.
2. Insert the DuraLabel Bronco Installation CD into your computer's CD drive. When the DuraLabel Bronco startup screen appears, choose Install Driver. (If your computer does not have a CD drive, you can download the driver installer from GraphicProducts.com/support, and run that program to continue.)



NOTE: If inserting the CD does not automatically show the DuraLabel Bronco screen, go to Start > Computer and double-click on your CD/DVD drive, which should show the DL icon.

3. Accept the license agreement and click Next.

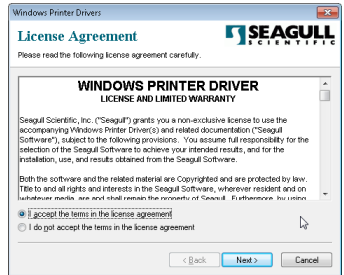

4. Choose an installation directory; by default, this will be "C:\Seagull." Then, click Next.

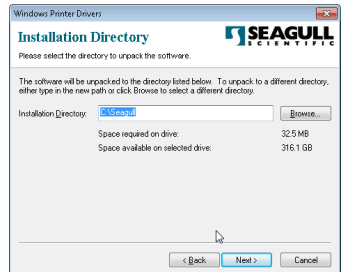

CONNECTING THE PRINTER

5. Make sure that the option to “Run Driver Wizard after unpacking drivers” is checked, and click Finish.

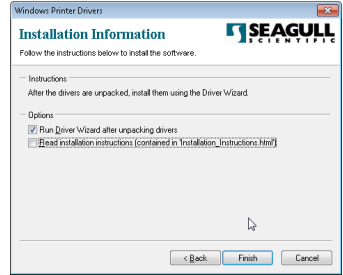

6. When the Driver Wizard starts, the program should automatically detect your Bronco. Select the entry for your Bronco (in the list under “Install a driver for a Plug and Play printer”) and click Next.

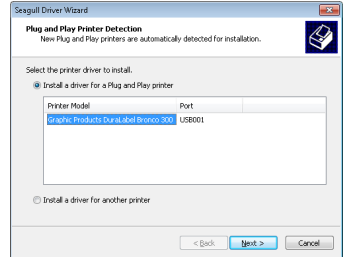

7. Choose a name for your Bronco; by default, this will be “Graphic Products DuraLabel Bronco 300.” You can also choose whether Bronco should be your default printer, or if you want to share your Bronco over a local network. Make your selections and click Next.



8. Review the installation details and click Finish to install the driver. You will see a progress bar as the software is installed.



5. Choosing Driver Settings

We recommend checking your Bronco's settings before beginning any print job. Changes to these settings may not take effect correctly if your label design software is already running; we recommend closing any open programs, making the necessary changes, and then opening your label design.

In most cases, you will only need to change these settings when you load a new type of label stock or printing ribbon, so that is an excellent time to make the necessary changes.

The best way to adjust these settings is through the Devices and Printers window:

1. In your computer's Start menu, choose "Devices and Printers." (If you do not see this option, open the Control Panel and choose "Devices and Printers" there.)
2. Right-click the entry for your Bronco and choose Printing Preferences. The driver settings window will open.

This window has several tabs: Page Setup, Graphics, Stock, Options, and About. (The About tab has no options, only information about your driver software.)

5.1 Page Setup

The first tab of the driver settings is for basic label controls, such as print orientation. For most label designs, the orientation will need to be set to Landscape. The Stock Name setting, which lets you set custom label dimensions, can be left on the default setting (USER) when you use label design programs such as DuraSuite or LabelForge.

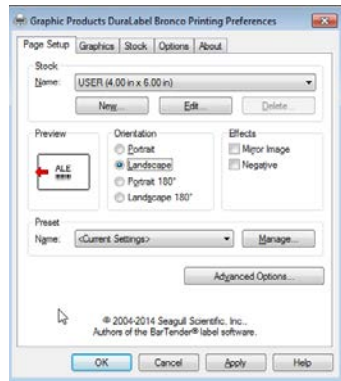

5.2 Graphics

This tab includes options for Dithering, which describes using a pattern of small dots to approximate different levels of darkness. For bold, clear labels, this should typically be set to None; for complex labels with multiple shades of gray, the Halftone option is usually best.

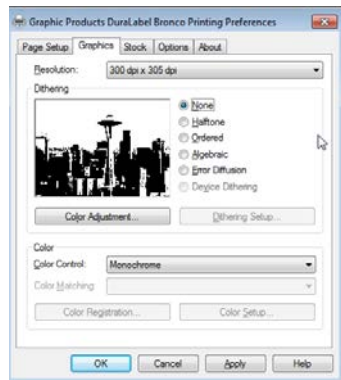

5.3 Stock

This tab includes options for different types of label stock and how your Bronco will handle them.

5.3.1 PRINT METHOD

For nearly all label materials, the Print Method should be set to Thermal Transfer. Some unusual materials do not require a printing ribbon, and can be used with the Direct Thermal printing method.

5.3.2 MEDIA TYPE

This option describes the type of label stock that you have loaded:

- **Continuous:** an uninterrupted, continuous roll of label stock (the most common supply type)
- **Label With Gaps:** a roll of pre-cut labels, usually pre-printed with some elements, with small gaps between labels
- **Labels With Marks:** a roll of partially pre-printed labels, with black marks on the backing to distinguish one label from the next

If the wrong Media Type has been selected, Bronco may print and cut in the wrong place on your roll of label stock, or it may give an error.

5.3.3 POST-PRINT ACTION

This option decides whether Bronco will cut your labels from the roll of supply, or take no action after printing, and leave your labels connected to each other.

5.3.4 OCCURRENCE

If you want Bronco to cut your labels, you can also set when the cutter runs: after every label, after identical copies, after a set number of labels, or after each complete print job.

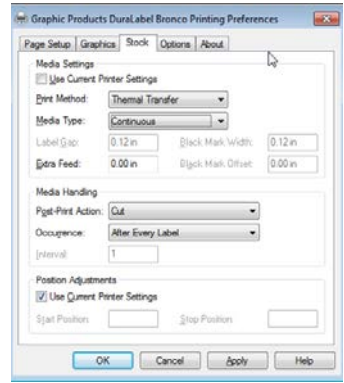

5.4 Options

When needed for troubleshooting, you can adjust the print speed and darkness settings for your Bronco here. The darkness setting controls how much heat is used during the printing process; some printing supplies require different amounts of heat to print with the best quality.

- Increasing the heat can clear up problems with faint or “faded” printing.
- Lowering the heat may be needed if the ribbon “snaps” or wrinkles during the print.

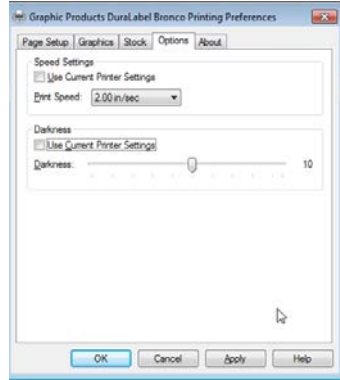

6. Installing Labeling Software

6.1 Installing DuraSuite Labeling Software

DuraSuite Labeling Software lets you create professional-quality pipe markers, arc flash, NFPA Diamond, RTK, GHS, and custom labels, quickly and easily.

To install, from the DuraLabel Bronco startup screen, click on DuraSuite Label Software and follow the directions that appear. Refer to the DuraSuite Labeling Software User Guide for additional information.

.....
NOTE: You may need IT administrator privileges to perform this installation.
.....

6.2 Installing LabelForge Labeling Software

LabelForge Labeling Software lets you design your own custom labels and signs and includes barcode creation tools for 2D and linear barcoding.

To install, from the DuraLabel Bronco startup screen, click on LabelForge Label Software and follow the directions that appear. Refer to the LabelForge Labeling Software User Guide for additional information.

.....
NOTE: You may need IT administrator privileges to perform this installation.
.....

7. Maintenance and Troubleshooting

7.1 Cleaning your Bronco

Periodic cleaning of the print head, cutter blade, and platen roller will prolong your Bronco's life, and allow clear print quality on every label. This cleaning process is simple and can be performed by any user. You will need cleaning swabs provided by Graphic Products, or a soft cloth and isopropyl alcohol, to clean the system properly.

We recommend that you clean the Bronco when you change supplies, as this may be the most convenient time. Cleaning will take less than five minutes.

1. Before cleaning your Bronco, turn it off using the power switch in the back of the printer, near the black power cord.
2. Open Bronco's lid and raise the print head carriage, as you would if you were loading supplies.
3. Temporarily remove the ribbon take-up core and any loose ribbon from the print head carriage, so that the metal print head on the underside of the carriage is exposed.
4. Using the cleaning swab or soft cloth and isopropyl alcohol, gently wipe the entire print head clean.
5. Temporarily roll back any label stock so that the rubber roller is exposed. Wipe the exposed part of the roller.
6. Wipe the cutter blades by carefully inserting the cleaning swab from the front of the cutter module and wiping from side to side.
7. Allow all parts to dry for a minute or so. Then, reload your supplies, close your Bronco again, and return to printing.

7.2 Troubleshooting

7.2.1 RECALIBRATING BRONCO'S SENSORS

If you are using die-cut or partially-printed label stock, and Bronco is not printing or cutting the labels in the right place, the printer's internal sensors may need to be recalibrated.

1. First, make sure that the printing preferences have been set correctly. Save any open work and close your label design program. Then, use the Devices and Printers window to set the driver settings appropriately for your label stock. (See section "Choosing Driver Settings".)
2. Then, turn off your Bronco using the switch at the back of the printer.

3. While the printer is off, press and hold the Feed/Cancel button on the top of the printer. Turn the printer on again, continuing to hold the button.
4. The indicator light in the button will flash green and then glow solid red, and then blink red in a repeating pattern as long as you hold the Feed/Cancel button. When the red light is blinking, release the button.
5. Bronco will automatically feed label stock through as it recalibrates its sensors. When this stops, you can open the printer (as if you were changing supplies) and roll the label stock back to avoid waste. The leading edge of your next label should rest at the top of the black rubber roller, beneath the print head carriage.
6. Close your printer, open your label design again, and try printing once more.

7.2.2 CHECKING SUPPLY LOADING

Most of the errors that will prevent Bronco from printing are simply the result of a mis-feed of the supplies in the printer. If a problem occurs and the indicator light blinks red or yellow, follow these steps to check the supply loading.

1. Turn off the printer using the switch in the back, and open the lid as if you were going to load new supplies.
2. Raise the print head carriage by pressing the two green carriage release tabs, and check the ribbon:
 - a. Check that the printing ribbon unrolls from the back of the fresh ribbon roll, on the underside of the print head carriage.
 - b. Check that the ribbon is able to move smoothly from that fresh roll, up and over the metal print head, and up to the take-up roll on the top side of the print head carriage.
 - c. Check that the fresh roll of ribbon and the take-up roll of used ribbon are both seated correctly, with the notches in the rolls fitting onto tabs on their holders.
3. Now, look at the label stock:
 - a. Check that the roll of label stock is roughly centered on its spindle, with the label stock unrolling from it so that the print surface (and not the paper backing) is facing up.
 - b. Check that the label stock is feeding between and beneath the two movable green guides, under the print head carriage.
 - c. Check that the label stock is reaching over the top of the gray rubber roller under the print head.

4. After checking the supplies, press the print head carriage back down until it latches securely on each side. Close the lid, and turn the printer on again. Your label may print out correctly as the printer restarts.

If you have any further questions, please contact us for help at 800.788.5572. Graphic Products is proud to offer free technical support for the lifetime of our printers.

8. Warranty and Certifications

8.1 5-Year DuraLabel Printer Warranty

Graphic Products' DuraLabel printers are warranted to be free from defects in materials and workmanship for a period of five (5) years from the date of purchase. Within this period, Graphic Products, Inc. will, at its sole option, repair or replace any components which fail in normal use. Such repairs or replacement will be made at no charge to the purchaser for parts or labor, provided that the purchaser shall be responsible for any transportation cost. This warranty does not cover loss, damages from accident, or equipment or parts which have been misused, altered, neglected, carelessly handled, used for purpose other than those for which the printer was manufactured, or damages resulting from unauthorized service.

8.1.1 REPAIRS

Repairs are warranted for 90 days. If the original warranty is still in effect, repaired units will remain under their original warranty or for 90 days from the date of service, whichever is longer.

8.1.2 WARRANTY DETAILS

The warranties and remedies contained herein are exclusive and in lieu of all other warranties whether express, implied, or statutory, including any liability arising under any warranty of merchantability or fitness for a particular purpose, statutory or otherwise. This warranty gives the purchaser specific legal rights, which may vary from state to state.

In no event shall Graphic Products be liable for any incidental, special, indirect, or consequential damages, whether resulting from the use, misuse, or inability to use the product for any reason including defect. Some states do not allow the exclusion of incidental or consequential damages, so the above limitation may not apply in all areas.

Graphic Products retains the exclusive right within all warranty periods to repair, replace, or offer a full refund of the purchase price at its sole discretion. Such remedy shall be the purchaser's sole and exclusive remedy for any breach of warranty.

General maintenance and cleaning of the DuraLabel printer is the purchaser's responsibility and is not covered by the warranty. Expendable items or parts such as label supply and ribbon are not covered by this warranty.

NOTE: Specific preparation may be required before shipping. Please contact your Graphic Products representative to ensure correct return procedure: please call 800.788.5572 for details. Graphic Products, Inc. shall not be responsible for any loss or damages incurred during shipping.

8.2 5-Year DuraLabel Premium Vinyl Warranty

DuraLabel supplies are tested for durability under various conditions, including UV exposure, moisture, heating and cooling cycles, abrasion, and chemical exposures. Graphic Products warranties labels made from its Premium vinyl supplies for a period of five (5) years.

Within five years of purchase and after proper application, Graphic Products will replace labels made with DuraLabel Premium Vinyl which become unreadable or fail to maintain adhesion with the labeled surface. In such instance, Graphic Products, Inc. will provide a one-time replacement roll of the same supply.

8.3 FCC Compliance

This equipment has been tested and found to comply with the limits for a Class A digital device, pursuant to part 15 of the FCC Rules. These limits are designed to provide reasonable protection against harmful interference in a residential installation. This equipment generates, uses and can radiate radio frequency energy and, if not installed and used in accordance with the instructions, may cause harmful interference to radio communications. However, there is no guarantee that interference will not occur in a particular installation. If this equipment does cause harmful interference to radio or television reception, which can be determined by turning the equipment off and on, the user is encouraged to try to correct the interference by one or more of the following measures:

- Reorient or relocate the receiving antenna.
- Increase the separation between the equipment and receiver.
- Connect the equipment into an outlet on a circuit different from that to which the receiver is connected.
- Consult the dealer or an experienced radio/TV technician for help.

To comply with the FCC RF exposure requirements, no change to the antenna or the device is permitted. Any change to the antenna or the device could result in the device exceeding the RF exposure requirements and void the user's authority to operate the device.

8.4 US, Canadian and European EMC and EMI standards

This equipment has been tested and passed with the requirements relating to electromagnetic compliance based on the standard EN 300 330-2 V1.5.1 (2010-02). Per RSS-Gen, Section 8.4 this device complies with Industry Canada license-exempt RSS standard(s). Operation is subject to the following two conditions: (1) this device may not cause interference, and (2) this device must accept any interference, including interference that may cause undesired operation of the device. This includes Industry Canada (IC) certification number 9684A-DLBRONCO.

9. Specifications

PRINTER

- **Type:** Thermal Transfer
- **Print Speed:** up to 3" per second (76.2 mm/s)
- **Resolution:** 300 dots/inch (12 dots/mm)
- **Max. Print Width:** 4.16" (105.7 mm)
- **Max. Print Length:** 30" (762 mm)
- **Agency Approvals:** CE , FCC Class A, IC

INDICATORS & BUTTONS

- **Indicators:** x1 tri-color LED: Power (green, orange, and red)
- **Buttons:** Feed

COMMUNICATION AND DATA STORAGE

- **Communication(s):** USB 2.0
- **Data Storage:** 4 GB Flash, 8MB SDRAM

POWER REQUIREMENTS

- **Input Voltage:** 24 VDC, 2.5A
- **Different AC adapters available for worldwide usage**

ENVIRONMENT

- **Operating Temperature:** 41° F to 104° F (5° C to 40° C)
- **Operation Humidity:** 30% - 85%, non-condensing
- **Storage Temperature:** -4° F to 122° F (-20° C to 50° C)
- **Storage Humidity:** 10% - 90%, non-condensing

LABEL STOCK

- **Type:** Continuous, Black Mark & Die-Cut
- **Width:** 0.25" (6.35 mm) minimum - with separate tape guide, 4.64" (118 mm) maximum
- **Max Label Roll Diameter:** 4.44" (113 mm)
- **Core Diameter:** 1" (25.4 mm)

RIBBON SUPPLY

- **Premium Resin**
- **Max. Width:** 4.33" (110 mm)
- **Capacity:** 360' (110 m) with 0.5" (12.7 mm) core diameter
- **Max. Ribbon Roll Diameter:** 1.57" (40 mm)
- **Core Diameter:** 0.5" (12.7 mm) with notch

PRINTER BODY

- **Dimensions:** 9.2"(W) x 11.8"(D) x 6.3"(H)
- **Weight:** 6.7 lbs (3.04 kg), excluding supplies

10. Contact Us

Graphic Products, Inc. has been a leader in custom labeling, signage, and visual communication solutions since 1970. Our commitment to providing world-class service is at the heart of everything we do.

If you have any further questions, or if any problems arise that are not addressed in this User Guide, please let us know. Graphic Products proudly offers free support to all of our customers.

Call us at:

800.788.5572 (U.S.A. and Canada only)

1.503.644.5572 (International)

Visit our website at *GraphicProducts.com*

Email us at info@graphicproducts.com



800.788.5572 | DuraLabel.com

©2018 Graphic Products, Inc. All Rights Reserved